

Mosquito Trap **BG - Sentinel 2** 

(EN) Instruction Manual

Updates for the manual can be found on the websites: www.biogents.com and bg-sentinel.com

Table of contents

Product components	3
Assembling the trap	4
Maintenance and care	7
Administering the carbon dioxide	8
Positioning of the trap	10
Power supply and electricity	11
Technical data	11
Contact	12

Product components

1. Intake funnel

2. Funnel net

3. Catch bag (2x)

4. Trap cover

5. Inner cylinder with attached ventilator

6. Trap body

7. Battery cable

8. Power cord with transformer (optional)

9. BG-Lure cartridge (optional)

10. CO₂ emitter nozzle (optional)

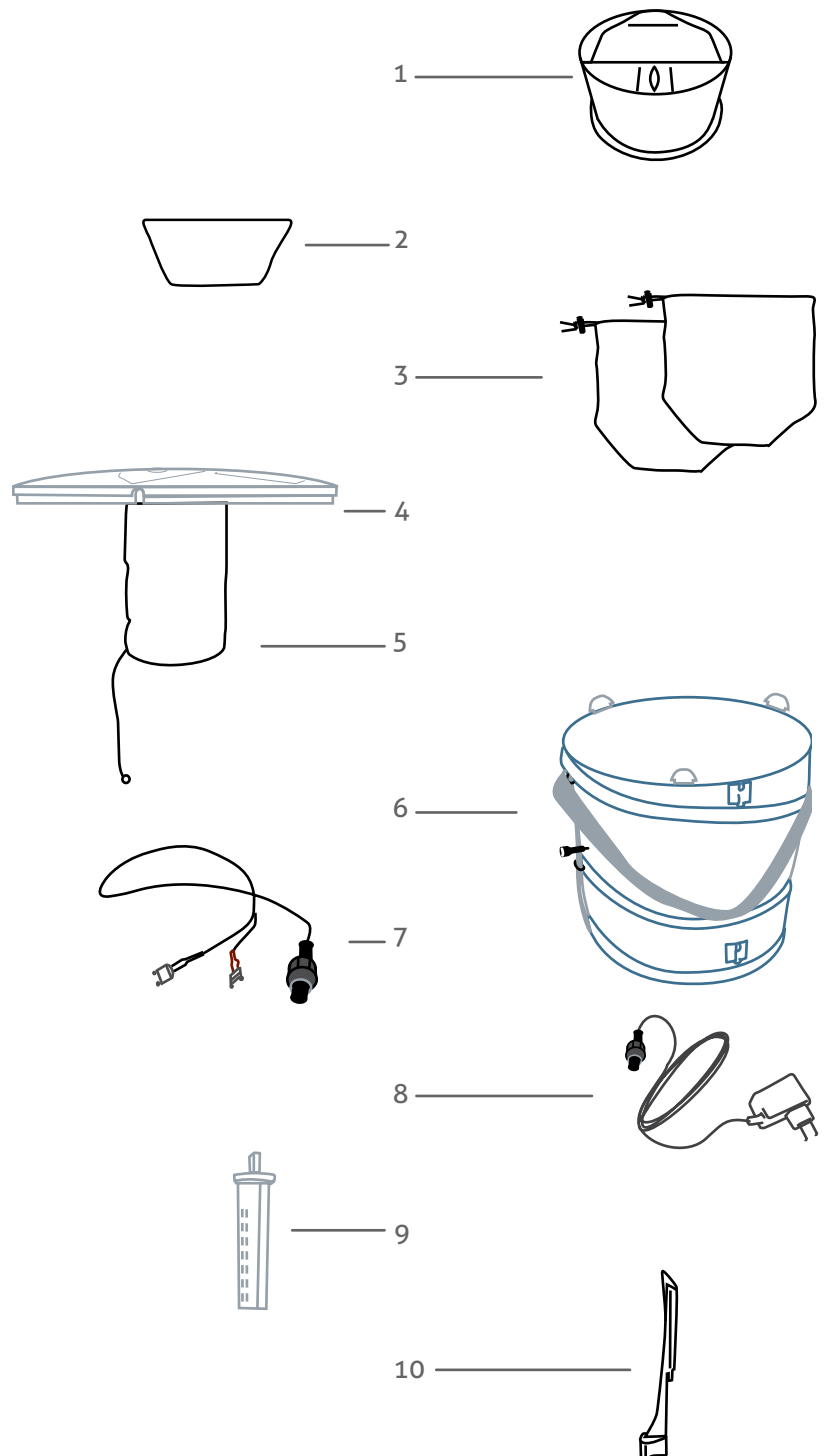

Assembling the trap

Please note:

The smell of the new material of the traps might have repellent effects on the mosquitoes. Therefore, we recommend to air out the traps by running them outside for two weeks before using them in the field to get rid of the smell.

1. Open the Biogents trap carrying bag and take out the components [F1].
2. Unhook the eyelet on the carrying handle and pop up the trap body [F2].
3. First attach the funnel net (optional) and then the catch bag over the protruding ring of the intake funnel [F3]. Tighten the top part of the catch bag.
4. Insert the intake funnel with the attached funnel net and catch bag into the opening on top of the cover [F4].
5. Unwrap the plastic label from the BG-Lure cartridge [F5].
6. Pop out the white Biogents disc from the hole in the cover when using the BG-Lure cartridge [F6].

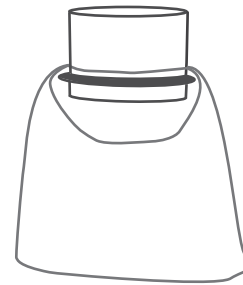

F3

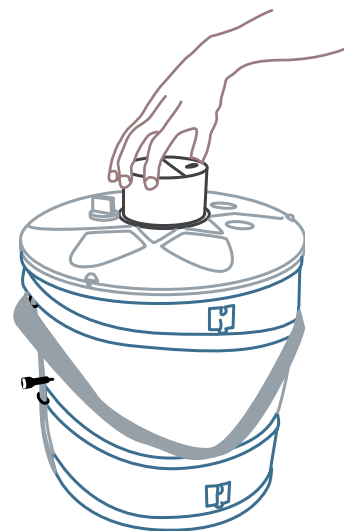

F4

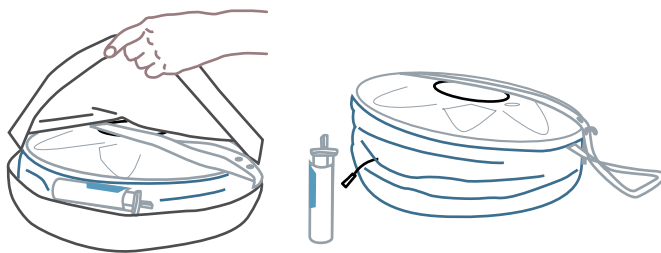

F1

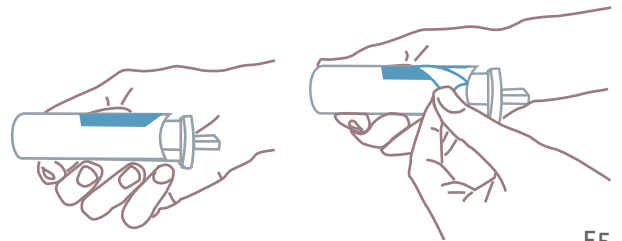

F5

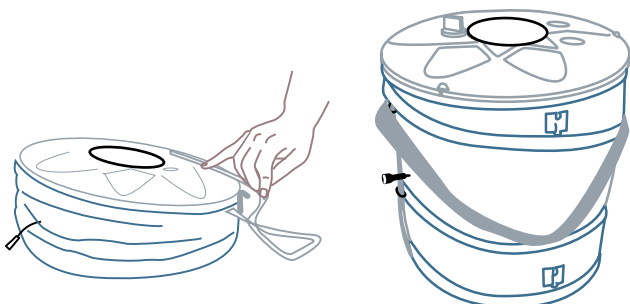

F2

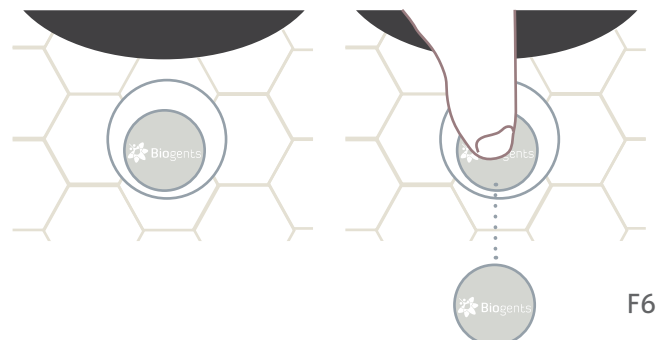

F6

6. Insert the desired attractant into the trap. When using the BG-Lure cartridge it can be placed into the hole in the cover [F7].
7. Connect the battery to the battery cable [F8]. Alternatively you can plug in the power transformer [F10]. Connect the open ends of the battery cable with the ventilator cable. Please pay attention to always connect with the arrows in one line [F9].

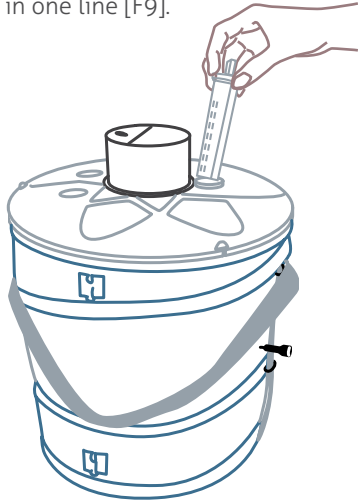

F7

8. When the power is turned on, the shutter will automatically tilt open [F11]. When the power is shut off or if the battery fails, the shutter automatically closes which ensures that the caught mosquitoes cannot escape.

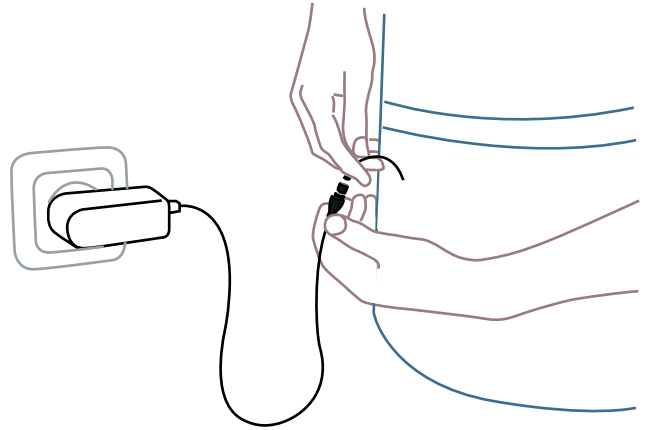

F10

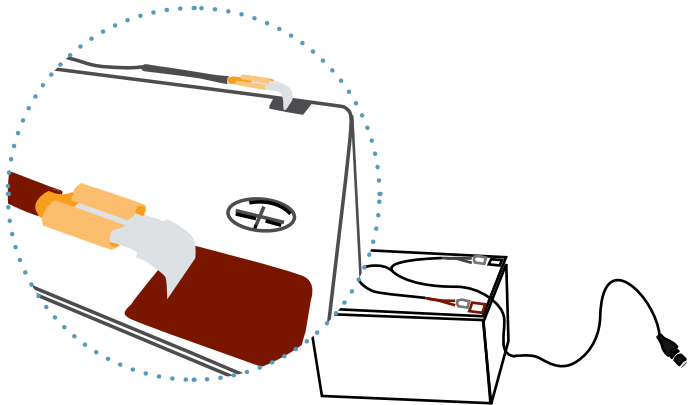

F8

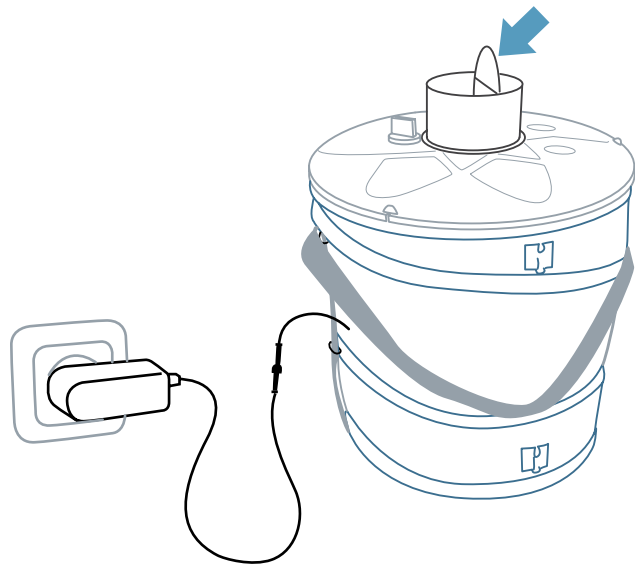

F11

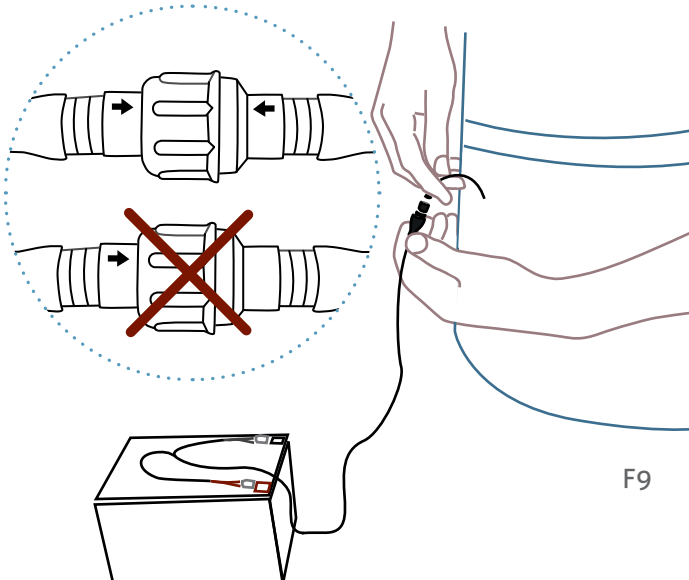

F9

9. Alternatively, you can place the battery within the body of the trap. For this purpose open the trap by unhooking the clips of the cover [F12] and remove the cover [F13].
10. Place the battery into the fixed straps located on the bottom of the body and tighten the strap [F14].
11. Connect the battery cable to the battery [F15] and guide the other end of the cable out of the opening on the side of the trap [F16].
12. Connect the open ends of the battery cable with the ventilator cable [F17]. The trap is now running and the shutter of the intake funnel will tilt open. You can easily disconnect and connect the cables to switch the trap off or on without the need of opening the trap body.

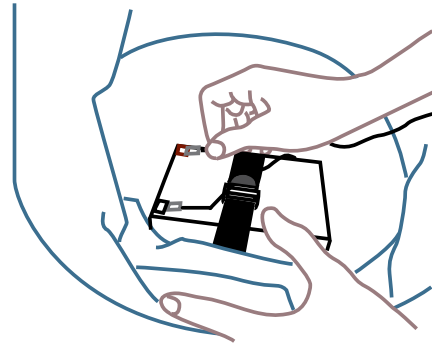

F15

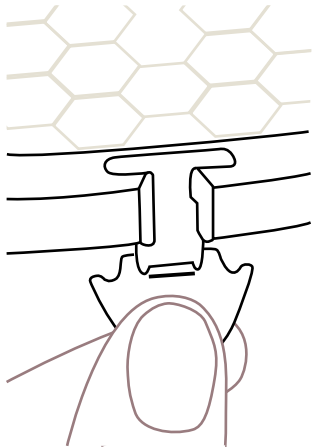

F12

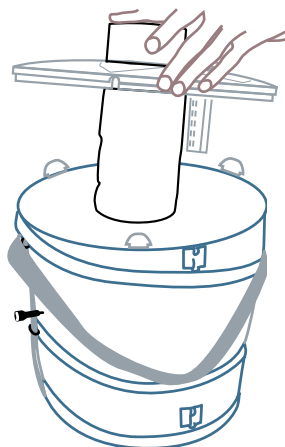

F13

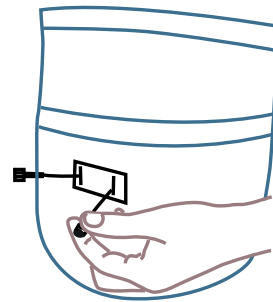

F16

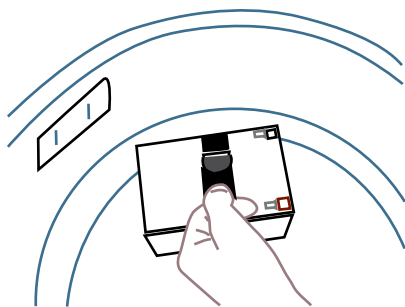

F14

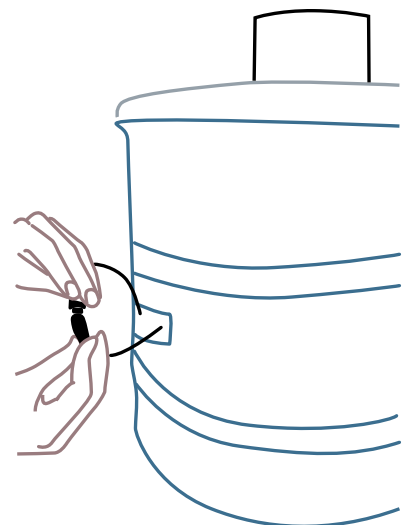

F17

Maintenance and care

To clean the plastic parts of the trap and the catch bags, use clear water. Do not use any cleaning agents or solvents because the residues from these products can have a repelling effect for the mosquitoes and consequently reduce the catch rate of the trap.

Replacing the catch bag

The intake funnel together with the catch bag can be used as a collection and transportation unit. The new shutter in the intake funnel can be fixed for this purpose and will ensure that no mosquitoes escape during transport.

1. To remove the mosquitoes, first fix the shutter of the intake funnel by pressing together the intake funnel at the axis of the shutter and then pressing the tab down [F18]. The tab is now secured and the shutter cannot open.
2. Then remove the intake funnel with the catch bag by turning it counterclockwise and pulling it out [F19].
3. Alternatively, you can also remove the catch bag from the intake funnel. Lift the intake funnel approximately 10 cm out of the trap, keeping the catch bag within the suction current of the ventilator to ensure no mosquitoes escape. Carefully pull the catch bag off the intake funnel and simultaneously pull the cord of the catch bag tightly shut. You can set the intake funnel on the side of the trap while closing the catch bag [F20].

For further use of the insects (e.g. identification/classification) it is best to put them in a freezer for at least an hour to kill them. **Please be careful when handling the funnel when taking it out of the freezer. The plastic of the cold funnel may break easily when falling to the ground.** After several hours (or in some cases up to a day depending on ambient temperature and humidity) the caught mosquitoes will dehydrate and die within the trap. The trap does not damage the insects, but identification is complicated if the insects stay in the trap for more than 3 days and dry out or if they get wet. You should attach the catch bag to the intake funnel with the seam facing outwards in order to avoid mosquitoes getting stuck in the seam while emptying the catch bag.

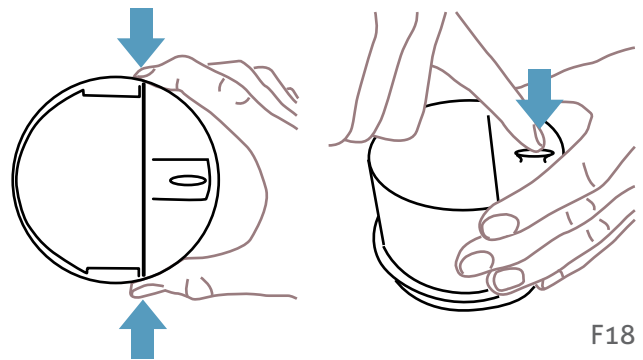

F18

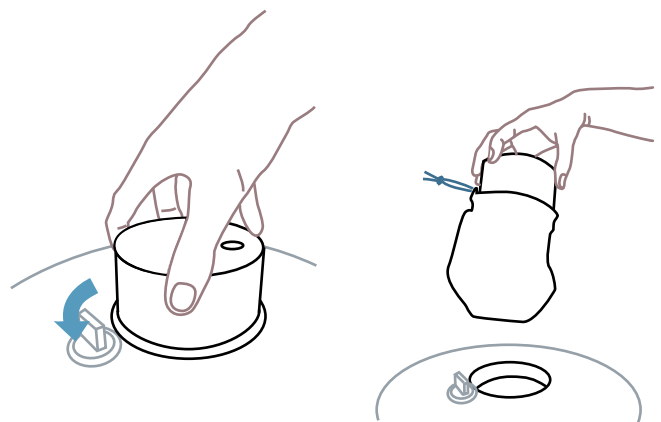

F19



F20

Administering the carbon dioxide

Without CO₂ the BG-Sentinel catches *Aedes aegypti*, *Aedes albopictus* and *Aedes polynesiensis* which are vectors of Dengue, Chikungunya, Filariasis and Yellow fever. It also catches some *Culex* species such as *Culex quinquefasciatus* and *Culex pipiens*; however, the addition of CO₂ enables you to catch a broader range of blood seeking species as well as much higher numbers of the previous mentioned species. Various sources of CO₂ can be used. The optional CO₂ nozzle can be attached to a gas cylinder, any well insulated dry ice container or another CO₂ source that fits your preference and that is placed away from the trap.

Fermentation of yeast:

Yeast-produced carbon dioxide can be produced by mixing 17.5 g of dry yeast, 250 g of sugar and 2½ L of tap water or 35 g of dry yeast, 500 g of sugar and 2½ L of tap water in a 5 L bottle. Capturing the foam to prevent the foam from entering the traps can be accomplished by a set up with two bottles. See detailed information for this protocol in a publication at <http://www.ncbi.nlm.nih.gov/pubmed/20973963>.

CO₂ gas cylinders:

In order to supply the trap with the carbon dioxide (CO₂) attractant, a commercially available CO₂ gas cylinder with two or more kilograms can also be used. These can be acquired or rented at drink retailers or bottle depots for a deposit. A door-to-door delivery service may also be possible. We recommend a 10 kg gas cylinder which is also used in restaurants for draft beer and soda.

Attaching the pressure reducing regulator onto the CO₂ gas cylinder:

The BG-Sentinel CO₂ trap includes a specialized pressure reducing regulator that is preadjusted to a constant output pressure of 0.7 bars. The pressure remains consistent throughout the entire usage. Screw the pressure reducing regulator onto the CO₂ gas cylinder by rotating the screw on the end of the regulator onto the opening on the CO₂ cylinder and make sure it is tight by using a wrench or pliers [F21].

Adjusting the CO₂ consumption with the CO₂ Y-tube containing the respective sinter plugs:

Biogents' sinter technology is an elementary component in the Biogents' catching system which optimizes the release of CO₂ and allows the adaptability to the local and seasonal conditions. Depending on the existing mosquito situation, you can choose between two different release rates: 200 grams/day and 500 grams/day. This allows the adaptation of the carbon dioxide emission to the local and seasonal mosquito situation.

When monitoring mosquito populations, the 500 grams/day release rate is recommended.

The Biogents BG-Sentinel CO₂ set includes a CO₂ tube with three endings. The two short ends at the Y-shaped connection each contain a sinter plug and can be attached to the pressure reducing regulator. The different sinter plugs are each marked with a colored band and label.

Attach either the red or blue end of the CO₂ Y-tube to the pressure reducing regulator. On the regulator with a screw on connection, unscrew the nut on the outlet, thread the end of the CO₂ tube through the nut, insert the end of the CO₂ tube onto the outlet and re-screw the nut back onto the outlet [F22].

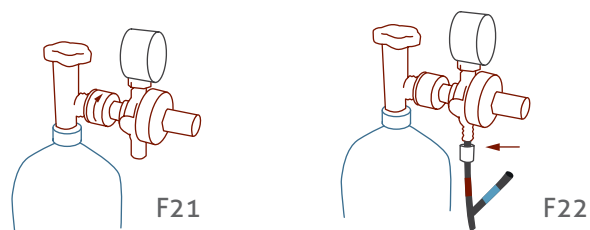

The other end of the CO₂ Y-tube with the sinter plug that is not attached to the regulator does not need to be closed off or attached to anything. The resistance from the sinter plug forces the entered CO₂ through the easier path down the CO₂ tube towards the trap.

The following is a consumption table of CO₂ comparing the two CO₂ flow rates:

Consumption Table of Carbon Dioxide			
CO ₂ Tube with Sinter Plug	CO ₂ Flow Rate in ml / min	CO ₂ Flow Rate in grams / day	Number of days a 10kg CO ₂ cylinder lasts
Blue - CO ₂ Flow Rate	70	200	50
Red - High CO ₂ Flow Rate	175	500	20

Attaching the CO₂ emitter nozzle to the trap:

Fix the CO₂ emitter nozzle onto the BG-Lure cartridge [F23]. If the BG-Lure is not used, insert the CO₂ nozzle into the same opening on the cover.

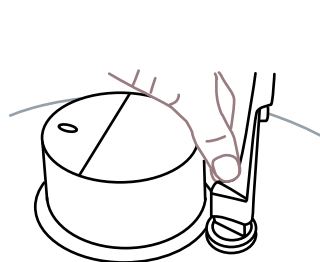

F23

Attaching the CO₂ tube to the nozzle on the trap:

Fix the long end of the CO₂ tube (opposite end of the Y-connection with sinter plugs) over the designated opening on the CO₂ emitter nozzle on the trap [F24]. Ensure a tight fit to avoid detachment of the tube from the nozzle.

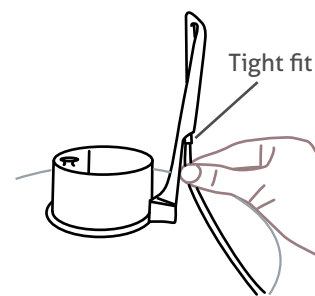

F24

Positioning of the trap

The correct placement of the trap is an important factor that heavily influences its effectiveness.

Position the trap in a location that is sheltered from wind, rainfall, and direct sunlight.
(Rainfall will not damage the trap as long as the fan is switched on.)

NOTE: The trap should not be placed too close to walls (min. distance of approx. 0,5 meter)

Optimal positioning:

- Ideal locations to position the trap are close to resting areas of mosquitoes such as bushes, shrubs, hedges, or any other foliage; however, placing the trap in very tall grass or under dense bushes will impair its effectiveness.
- The trap should also be positioned close to mosquito breeding sites such as various kinds of temporary stagnant water ranging from small lakes to collections of rain water in rain barrels or old tyres. Many mosquitoes do not need a large amount of water for breeding; even a can filled with rain water can be an ideal breeding place.



Important: The trap and all its upper surfaces should be clearly visible to patrolling mosquitoes, so that its specialized appearance is effective in attracting the mosquitoes. Therefore do not place the traps under very dense bushes. A distance of at least 0.5 meters above the top of the trap needs to be kept clear. Any distance lower will hinder the visual signals and air currents of the trap and consequently reduce the catch rate. A location under a sparse bush with adequate distance above the trap is a good position. Keep the trap out of strong wind. Strong winds not only deter the mosquitoes but can also affect the suction from the ventilator decreasing the catch rate.



Positioning examples:

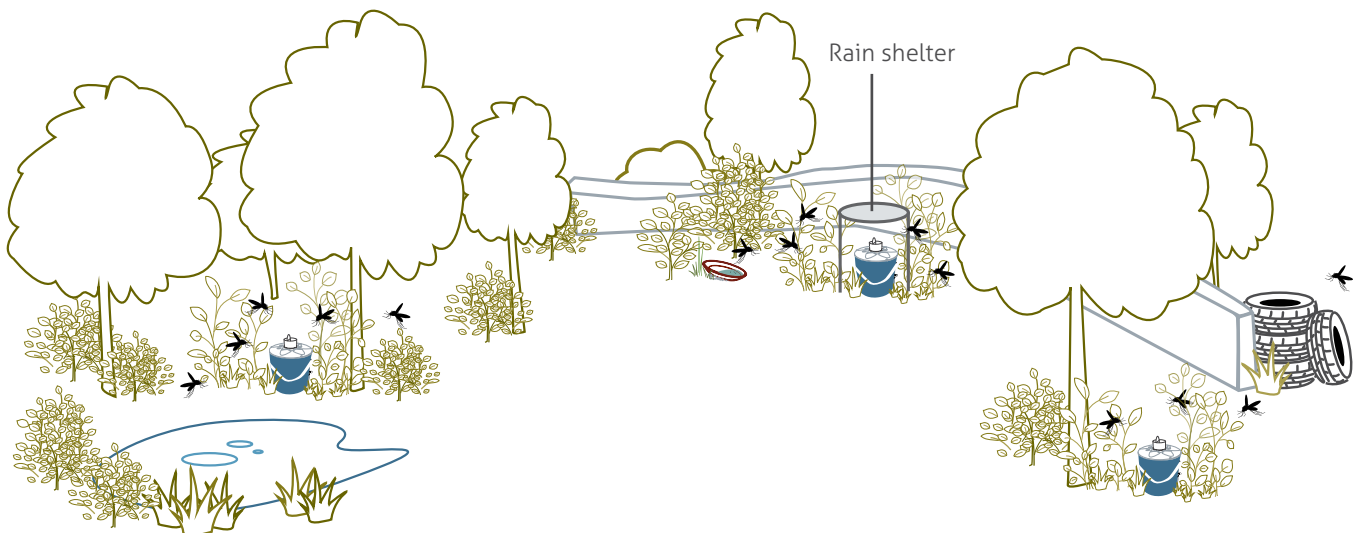

Sheltering the trap from rain:

Rain might disrupt the airflow by clogging the pores of the cover. This causes a reduction in the suction power of the ventilator. Therefore ensure that the trap is sheltered from rainfall. If the trap became very wet allow it to dry before the next monitoring.

Even though rainfall does not damage the trap, there are several negative effects of rain that might decrease the catch rate:

- The mosquitoes can be damaged and difficult to identify.
- Mosquitoes avoid rain and prefer sheltered positions. In sheltered positions the catch rate can be therefore higher.
- Rain clogs the pores of the cover which leads to a reduction of suction power causing the shutter to close.
- Other animals, such as snails, are attracted by a wet trap and tend to creep into the trap.

If you don't find a naturally sheltered position for the trap, it would be best to position the trap under a roofed area, or a self made shelter to keep it out of direct rainfall.

It is important to comply with the following regulations when sheltering the trap from rain:

- Whatever is placed over the trap must be at least 0.5 meters above the top surface of the trap. Any distance lower will hinder the visual signals and air currents of the trap and consequently reduce the catch rate.
- Make sure the shelter covers an adequate area around the trap, so that rain cannot enter from the sides.
- Make sure the shelter is stable and durable.

Power supply and electricity

The ventilator requires a power source of 9 to 12 V DC (max. 280 mA). While a battery cable is included, an optional power supply unit (EU Version, US version or Australian version with an input of 220V and an output of 12V) with fitting plug connection is also available.

When using batteries, we usually recommend 12 Volt motorcycle or car batteries. These are easily rechargeable and readily available in most places. As a rule of thumb, you will need a battery capacity of 10 to 11 Ah for each trap with a 24 hr trapping period (for a 48 hr period you will need a capacity of 20 to 22 Ah and so on). This includes a security factor which should give you a peace of mind in most real-life situations.

Technical data

Weight: 1.7 kg

Dimension unfolded: 38 x 47 cm

Dimension folded in bag: 42 x 13 cm

Ventilator: 12V DC, 3.6 Watt

Switching power supply: AC Input 100 – 230V,
Frequency 60Hz/50Hz,
DC Output 12V 1A

Contact

Biogents AG
Weißenburgstr. 22
93055 Regensburg
Germany
www.biogents.com
Email: sales@biogents.com